

Kalos

Fivep

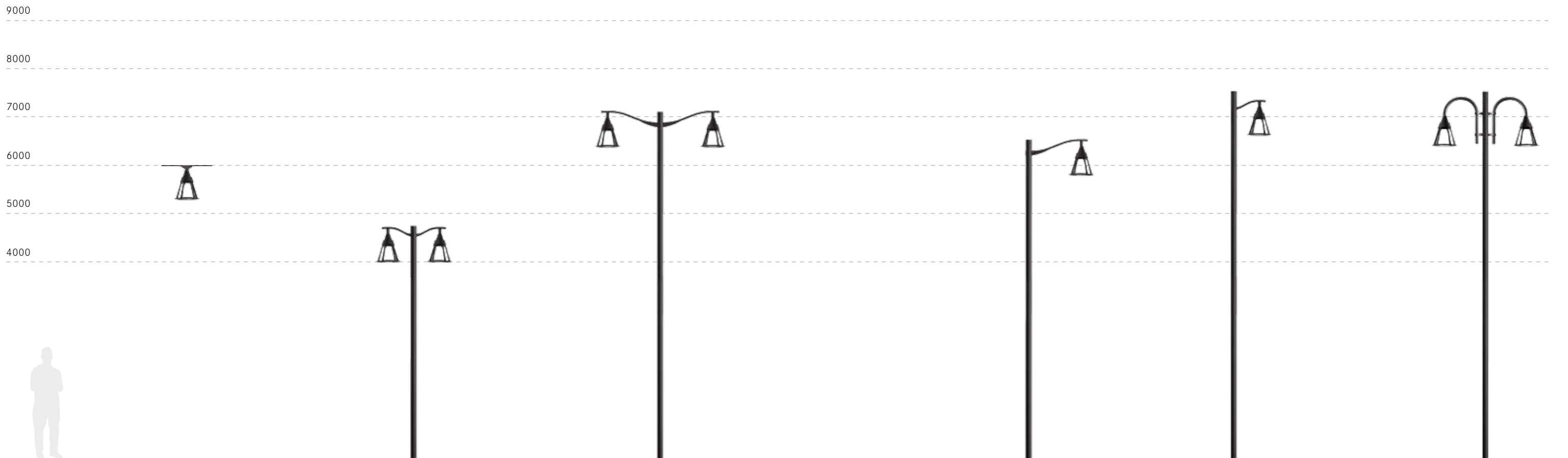

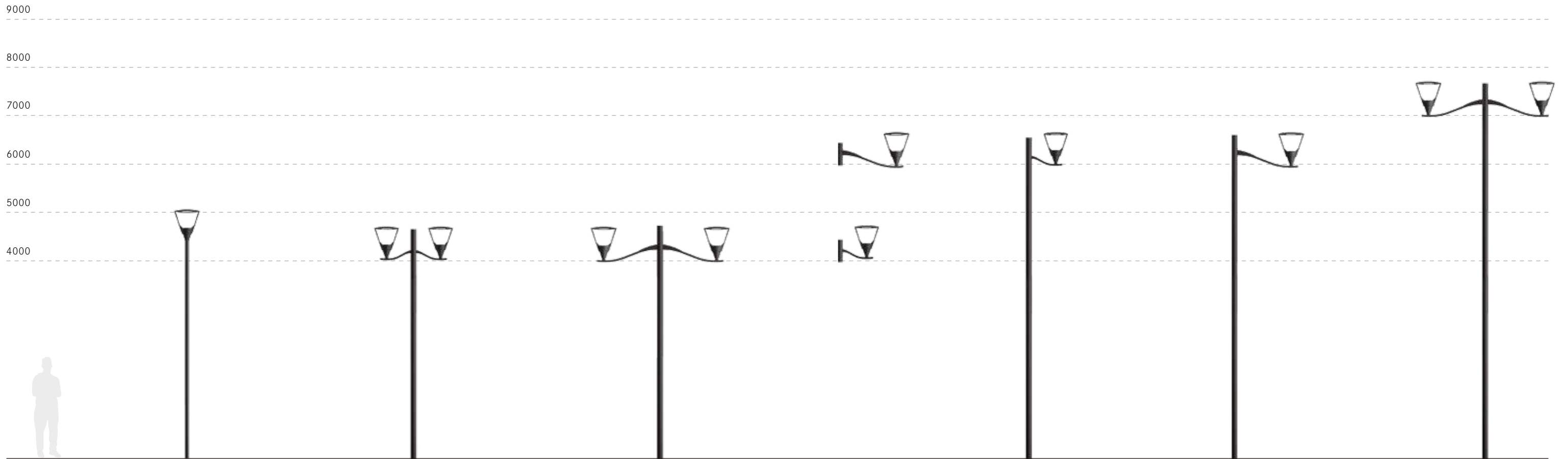



220-240V 50/60Hz	Tensione di alimentazione <i>Tension nominale</i> Tensión nominal
CL I on request CL II	Classe di isolamento elettrico <i>Classe d'isolation électrique</i> Clase de aislamiento eléctrico
IP66	Grado di protezione <i>Degré de protection</i> Grado de protección
IK09	Protezione contro gli urti <i>Protection antichoc</i> Protección contra impactos
>0.90	Fattore di potenza <i>Facteur de puissance</i> Factor de potencia
10kV	Protezioni da sovratensioni di modo comune <i>Protections contre surtensions de mode commun</i> Protecciones contra sobretensiones de modo común
10kV	Protezioni da sovratensioni di modo differenziale <i>Protections contre surtensions de mode différentiel</i> Protecciones contra sobretensiones de modo diferencial
-30°C +50°C	Temperatura ambiente <i>Température ambiante</i> Temperatura ambiente
Sablé100 Noir	Colori <i>Coloris</i> Colores
Included	Alimentazione elettronica <i>Alimentation électronique</i> Alimentación electrónica
HM3 CLO 1-10V Wireless on request PLC on request DALI on request Motion detectors/ brightness on request	Illuminazione intelligente <i>Éclairage intelligent</i> Iluminación inteligente

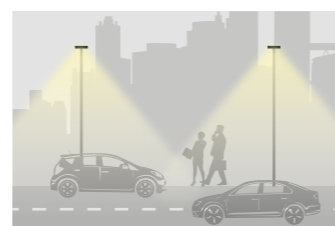
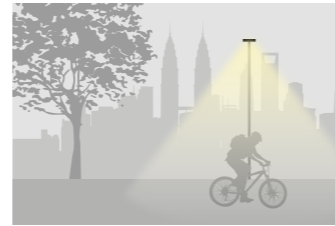

2120- 15435lm	Flusso sorgente <i>Flux source</i> Flujo de la lámpara
ULOR: 0% DLOR: 100%	Cut-Off <i>Cut-Off</i> Cut-Off
4000K 3000K 2200K	Temperatura colore <i>Température de couleur</i> Temperatura de color

≥70 ≥80 on request	Indice di resa cromatica (CRI) <i>Indice de rendu de couleur (IRC)</i> Índice de reproducción cromática (CRI)
> 160.000h @700mA @Ta25°C TM21 L80B20	Durata di vita delle sorgenti <i>Durée de vie des sources</i> Vida útil de las lámparas
> 160.000h @700mA @Ta25°C TM21 L80B10	

Ottiche asimmetriche stradali
Asymétrique routière optique Óptica asimétrica viaria

	ST-01 (L/H = 0.75) UP pole-side system	 I max= 699.22 cd/Klm
	ME-01 (L/H = 1) UP pole-side system	 I max= 813.88 cd/Klm
	ME-01 (L/H = 1) DOWN pole-side system	 I max= 772.55 cd/Klm
	LA-01 (L/H = 1.25) UP pole-side system	 I max= 661.87 cd/Klm
	LA-01 (L/H = 1.25) DOWN pole-side system	 I max= 623.41 cd/Klm

Ottiche Front & Back *Optique Front & Back* Óptica Front & Back

	ST-01 (L/H = 0.75) + LA-01 (L/H = 1.25) UP pole-side system	 I max= 436.21 cd/Klm
--	---	--------------------------

Ottiche rotosimmetriche *Roto-symétrique optique* Óptica rotosimétrica

	RS-01 UP pole-side system	 I max= 348.21 cd/Klm
--	-------------------------------------	--------------------------

Ottiche asimmetriche *Asymétrique optique* Óptica asimétrica

	LT-06 (L/H = 2) UP pole-side system	 I max= 798.53 cd/Klm
	LT-06 (L/H = 2) DOWN pole-side system	 I max= 757.91 cd/Klm

Ottiche simmetriche stradali
Symétrique routière optique Óptica simétrica viaria

	SO-01 string suspension	 I max= 502.87 cd/Klm
--	-----------------------------------	--------------------------

Installazione: palo, braccio, parete, tesata
Installation: mât, crosse, mur, chaîne
Instalación: poste, brazo, pared, tensada

L = Larghezza strada, *Largeur chaussée*, Longitud de la calle
H = Altezza palo, *Hauteur poteau*, Altura punto de luz

Approfondimento sistemi ottici, *Approfondissement des systèmes optiques*, Profundización de los sistemas ópticos P. 308

Approfondimento sistemi di smart lighting, *Approfondir les systèmes d'éclairage intelligents*, Profundización de los sistemas de iluminación inteligente P. 310



Sistema ottico multilayers
Système optique multicouche
Sistema óptico multicapa



CRI≥80 SMCD=4 su richiesta
CRI≥80 SMCD=4 sur demand
CRI≥80 SMCD=4 bajo pedido



Maggiore efficienza energetica
Efficacité énergétique majeure
Mayor eficiencia energética



Ta -30°C +50°C
Ta -30°C +50°C
Ta -30°C +50°C

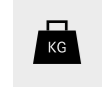

Dimensioni compatte
Dimensions compactes
Dimensiones compactas



Sostituibilità gruppo alimentazione
Substituabilité unité d'alimentation
Sustituibilidad del grupo de alimentación



Cut-Off
Cut-Off
Cut-Off



Ottica Front & Back
Optique Front & Back
Óptica Front & Back



160.000h
L80B20
L80B10
Maggiore durata vita delle sorgenti
Durée de vie plus longue des sources
Mayor vida de las lámparas



Resistenza sovratensioni fino a 10kV
Résistance surtension jusqu'à 10kV
Resistencia sobretensión de hasta 10kV



Trasporti ottimizzati
Transport optimisé
Transportes optimizados



Riduzione accumulo sporco
Réduction accumulation saleté
Menor suciedad acumulada

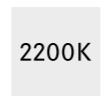

2200K
Luce calda 2200K
Lumière Chaude 2200K
Luz Cálida 2200K



Illuminazione intelligente
Éclairage Intelligent
Iluminación Inteligente



Resistenza agenti chimici/atmosferici
Résistance agents chimiques/atmosphériques
Resistencia agentes químicos/atmosféricos



CLO (Constant Lumen Output)
CLO (Constant Lumen Output)
CLO (Constant Lumen Output)



Sostituibilità gruppo ottico
Substituabilité groupe optique
Sustituibilidad del grupo óptico



Installazione UP&DOWN

Il sistema di fissaggio Kalos può essere installato in configurazione UP (testa palo o bracci in configurazione portata) o DOWN (sospensione su bracci o su fune tesata).

La versione UP è disponibile sia con due che con quattro bracci, quella DOWN è standard con quattro bracci. La versione UP quattro bracci può assumere una forma più classicheggiante se corredata del cappello dedicato.

Installation UP&DOWN

Le système de fixation Kalos peut être installé en configuration UP (tête de mât ou crosse en configuration portée) ou DOWN (suspension sur crosse ou sur cordage).

La version UP est disponible avec deux ou quatre crosses, la version DOWN est standard avec quatre crosses. La version UP à quatre crosses peut avoir une forme plus classique si elle est complétée du chapeau assorti.

Instalación UP&DOWN

El sistema de fijación Kalos se puede instalar en configuración UP (en extremo de poste o con brazos soportados) o DOWN (suspensión en brazos o con cable tesado).

La versión UP está disponible tanto con dos como con cuatro brazos, la versión DOWN se fabrica de serie con cuatro brazos. La versión UP de cuatro brazos puede adoptar una forma más clásica si va acompañada de la específica cubierta.

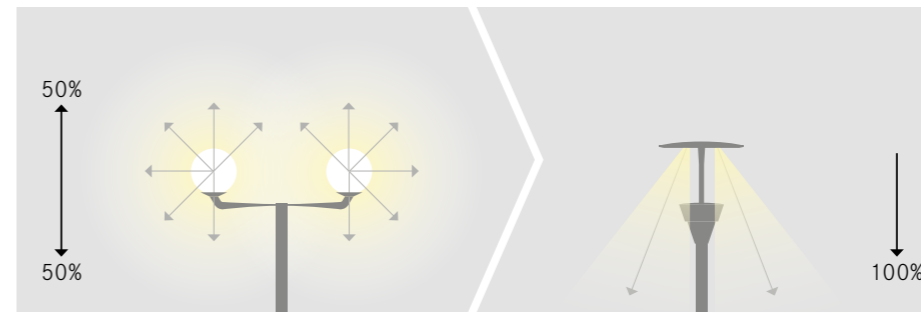

Impatto ambientale ridotto

La sostituzione di vecchi punti luce a lampada con i prodotti della linea Kalos consente un elevato risparmio energetico e una riduzione dell'inquinamento luminoso. (Cut-Off)

Impact environnemental réduit

Remplacer des anciens points de lumière à lampes par les produits de la gamme Kalos permet de faire des économies d'énergie importantes et de réduire la pollution lumineuse. (Cut-Off)

Impacto ambiental reducido

La sustitución de los antiguos puntos de luz en lámpara por los productos de la línea Kalos permite un elevado ahorro de energía y la reducción de la contaminación lumínica. (Cut-Off)

Energy Saving	75%
Light Pollution	0%
Life time	>50.000 h
On-off	immediately
Warranty	5 years



H: Altezza palo *Hauteur du mât* Altura de palo
H1: Altezza fonte luce *Hauteur point lumière* Altura de la fuente de luz
D: Interdistanza *Distance* Interdistancia
I/H: Rapporto interdistanza / altezza *Rapport hauteur / distance* Porcentaje altura / interdistanza
La: Larghezza strada *Largeur de la route* Longitud calle
Emed: Illuminamento medio *Eclairage moyen* Iluminación media
Emin: Illuminamento minimo *Eclairage minime* Iluminación mínima
W: Potenza totale *Puissance totale* Potencia total
STR: Ottica stradale *Optique routière* Óptica vial
ROT: Ottica rotosimmetrica *Optique rotosimétrique* Óptica rotosimétrica

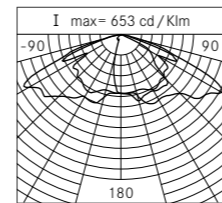

	H	H1	D	I/H	La	Emed	Emin	W
UNI 11248 (p2)				10	3			
KALOS 12 525 LED STR ST-01	4	4.6	22.5	5.6	3	137	4.94	20
CERVIA 125W QE	4	4.6	22.5	5.6	3	8	3	138
Energy saving	10LED 20W		vs	QE 125W 138W		-83%		

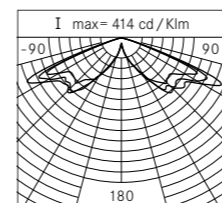
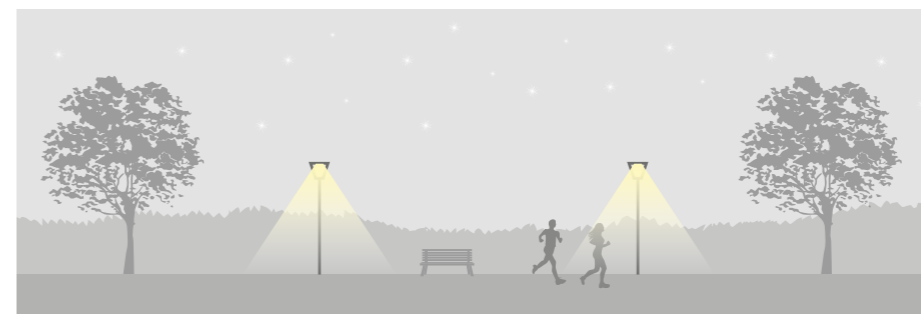

	H	H1	E Medio	U0	W	
80W QE	4	4.6	6	0.28	88	
125W QE	4	4.6	10	0.28	138	
100W SE	4	4.6	17	0.28	115	
KALOS 12 350 LED ROT	4	4.6	7,5	0.34	14.5	
KALOS 12 700 LED ROT	4	4.6	11	0.34	28	
Energy saving	12LED 14.5W		vs	QE 88W 88W		-83%
Energy saving	12LED 28W		vs	QE 125W 138W		-66%

220 240V	50 60Hz	CL II	IP66	IK09
-------------	------------	-------	------	------



Kalos UP brackets and poles

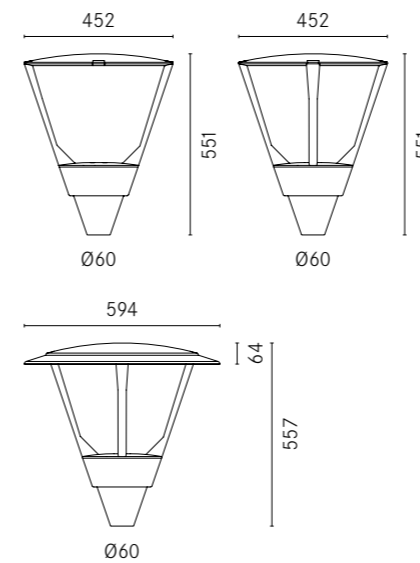

Max weight: 8 kg
 Max exposed surface: 0.16m²
 Lateral exposed surface: 0.068m²

Kalos UP 2 arms 01KA4		Kalos UP 4 arms 01KA5			
Led (source flux) Ref. @700mA @4000K					
3965lm 24W B2	7845lm 48W C4	11660lm 72W D6			
Led (source flux) Ref. @700mA @3000K					
3780lm 24W B2	7480lm 48W C4	11120lm 72W D6			
mA					
700	525	350	0		
K					
4000 0	3000 9	2200* 1	*Only 48W and 72W Optics LA-01 / ME-01 / LT-6		
Optics					
ST-01 30	ME-01 32	LA-01 31	RS-01 35	LT-06 37	*3965lm + 3965lm **7845lm + 7845lm
ST-01 + LA-01* 76		ST-01 + LA-01** 77			
Colors					
Sablé100 C					
Smart Lighting					
Preset virtual midnight HM3					

Esempio Exemple Ejemplo

01KA4	B2	0	0	35	C	HM3
--------------	-----------	----------	----------	-----------	----------	------------

Accessori Accessoires Accesorios

01AY904C0 - Sablé100

Riduzione Ø 60-68 mm per pali Ø 76 mm
 Réduction Ø 60-68 mm pour mâts Ø 76 mm
 Reducción Ø 60-68 mm para postes Ø 76 mm



01SC913C0 - Sablé100

Riduzione Ø 60-114 mm per pali Ø 102 mm
 Réduction Ø 60-114 mm pour mâts Ø 102 mm
 Reducción Ø 60-114 mm para postes Ø 102 mm

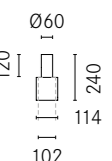

01KA901C0 - Sablé100

Cappello (solo per versione 4 chele)
 Chapeau (seulement pour version 4 crosses)
 Sombrero (solo para version 4 brazos)

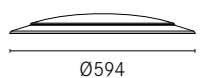

Verifica compatibilità con pali e bracci. Vérifier la compatibilité avec les poteaux et les crosses. Verificar compatibilidad con postes y brazos. P. 316

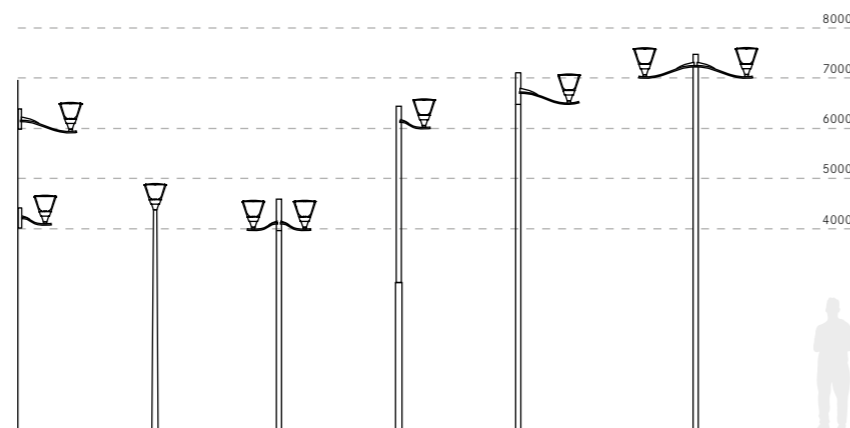

220 240V	50 60Hz	CL II	IP66	IK09
-------------	------------	-------	------	------



Kalos DOWN brackets and poles

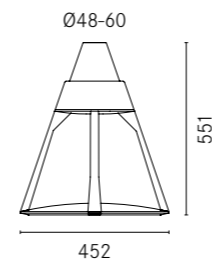

Max weight: 8 kg
 Max exposed surface: 0.16m²
 Lateral exposed surface: 0.068m²

Kalos DOWN 4 arms
01KA6

Led (source flux) Ref. @700mA @4000K

3965lm 24W B2	7845lm 48W C4	11660lm 72W D6
-------------------------	-------------------------	--------------------------

Led (source flux) Ref. @700mA @3000K

3780lm 24W B2	7480lm 48W C4	11120lm 72W D6
-------------------------	-------------------------	--------------------------

mA

700	525	350
0		

K

4000	3000
0	9

Optics

ME-01 32	LA-01 31	LT-06 37
--------------------	--------------------	--------------------

Colors

Sablé100 C

Smart Lighting

Preset virtual midnight HM3

Esempio Exemple Ejemplo

01KA6	B2	0	0	32	C	HM3
--------------	-----------	----------	----------	-----------	----------	------------

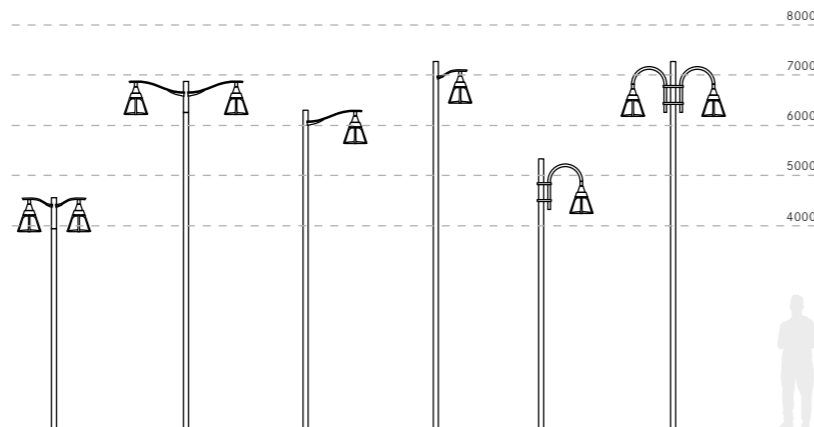

Accessori Accessoirs Accesorios

01KA915C0 - Sablé100

B53 Kit sospensione plafone
 B53 Kit de suspension au plafond
 B53 Kit de suspensión de techo

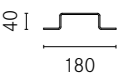

Versione con LED rosso, disponibili altre colorazioni su richiesta
 Variante avec LED rouge, d'autres couleurs disponibles sur demande
 Versión con LED rojos, otros colores disponibles a pedido



Verifica compatibilità con pali e bracci. Vérifier la compatibilité avec les poteaux et les crosses. Verificar compatibilidad con postes y brazos. P. 316

220 240V	50 60Hz	CL II	IP66	IK09
-------------	------------	-------	------	------



Kalos DOWN string suspension

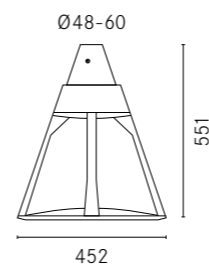

Max weight: 8 kg
 Max exposed surface: 0.16m²
 Lateral exposed surface: 0.068m²

Kalos DOWN 4 arms
01KA6

Led (source flux) Ref. @700mA @4000K

7845lm 48W C4	15435lm 95W E8
-------------------------	--------------------------

Led (source flux) Ref. @700mA @3000K

7480lm 48W C4	14720lm 95W E8
-------------------------	--------------------------

700	525	350
0		

4000	3000
0	9

Optics

SO-01
39

Colors

Sablé100
C

Smart Lighting

Preset virtual midnight
HM3

Esempio Exemple Ejemplo

01KA6	C4	0	0	39	C	HM3
--------------	-----------	----------	----------	-----------	----------	------------

Accessori Accessoirs Accesorios

01KA925C0 - Sablé100

Kit sospensione fune tesata Ø6-12mm
 Kit fixation suspension sur cordage Ø6-12mm
 Kit conexión suspensión tensada Ø6-12mm

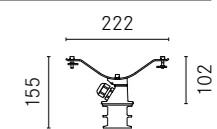

Versione con LED rosso, disponibili altre colorazioni su richiesta
 Variante avec LED rouge, d'autres couleurs disponibles sur demande
 Versión con LED rojos, otros colores disponibles a pedido

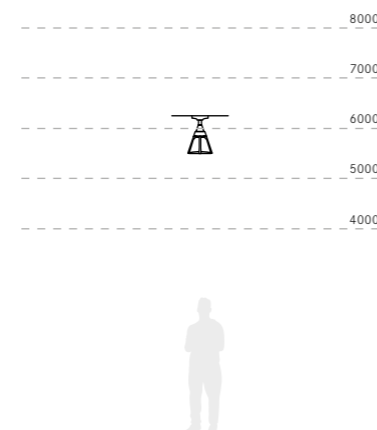

Accessori Accessoires Accesorios

01KA902C0 - Sablé 100

B35 Braccio L 1000mm per palo Ø102mm con codolo TP Ø60mm H 120mm

B35 Crosse L 1000mm pour poteau Ø102mm avec support tête mât Ø60mm H 120mm

B35 Brazo L 1000mm por columna Ø102mm con apoyo extremo de poste Ø60mm H 120mm

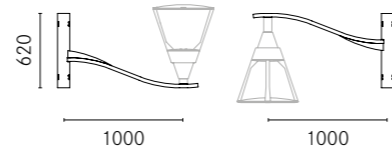
**01KA903C0 - Sablé 100**

B36 Braccio doppio L 1000mm per palo Ø102mm con codolo TP Ø60mm H 120mm

B36 Crosse double L 1000mm pour poteau Ø102mm avec support tête mât Ø60mm H 120mm

B36 Brazo doble L 1000mm por columna Ø102mm con apoyo extremo de poste Ø60mm H 120mm

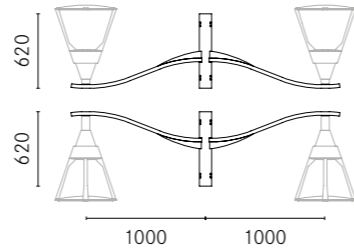
**01KA904C0 - Sablé 100**

B37 Braccio L 500mm per palo Ø102mm con codolo TP Ø60mm H 120mm

B37 Crosse L 500mm pour poteau Ø102mm avec support tête mât Ø60mm H 120mm

B37 Brazo L 500mm por columna Ø102mm con apoyo extremo de poste Ø60mm H 120mm

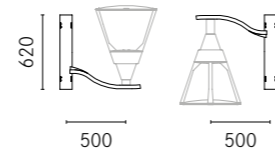
**01KA905C0 - Sablé 100**

B38 Braccio doppio L 500mm per palo Ø102mm con codolo TP Ø60mm H 120mm

B38 Crosse double L 500mm pour poteau Ø102mm avec support tête mât Ø60mm H 120mm

B38 Brazo doble L 500mm por columna Ø102mm con apoyo extremo de poste Ø60mm H 120mm

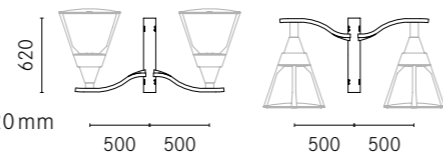
**01KA906C0 - Sablé 100**

B39 Braccio L 1000mm con anello per pali Ø102mm

B39 Crosse L 1000mm avec bague pour poteau Ø102mm

B39 Brazo L 1000mm con anillo por columna Ø102mm

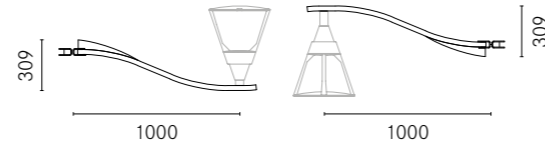
**01KA907C0 - Sablé 100**

B44 Braccio doppio L 1000mm con anello per pali Ø102mm

B44 Crosse double L 1000mm avec bague pour poteau Ø102mm

B44 Brazo doble L 1000mm con anillo por columna Ø102mm

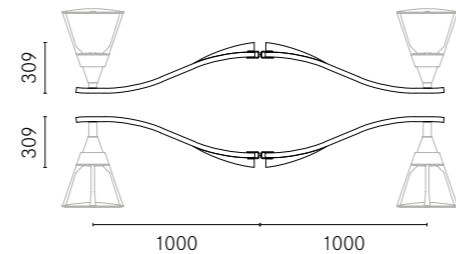
**01KA910C0 - Sablé 100**

B39-P Braccio per parete L 1000mm

B39-P Crosse mural L 1000mm

B39-P Brazo de pared L 1000mm

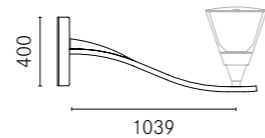
**01KA911C0 - Sablé 100**

B45-P Braccio per parete L 500mm

B45-P Crosse mural L 500mm

B45-P Brazo de pared L 500mm

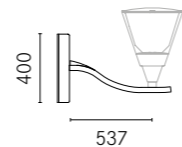
**01KA908C0 - Sablé 100**

B45 Braccio L 500mm con anello per pali Ø102mm

B45 Crosse L 500mm avec bague pour poteau Ø102mm

B45 Brazo L 500mm con anillo por columna Ø102mm

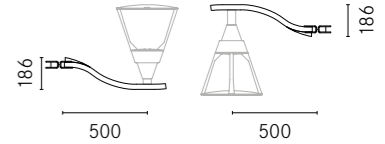
**01KA909C0 - Sablé 100**

B46 Braccio doppio L 500mm con anello per pali Ø102mm

B46 Crosse double L 500mm avec bague pour poteau Ø102mm

B46 Brazo doble L 500mm con anillo por columna Ø102mm

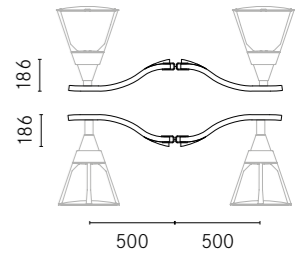
**01AK932C0 - Sablé 100**

B12 Braccio pastorale L 640mm Ø60mm per palo TP Ø60mm

B12 Crosse courbe L 640mm Ø60mm pour poteau tête mât Ø60mm

B12 Brazo báculo L 640mm Ø60mm por columna extremo de poste Ø60mm

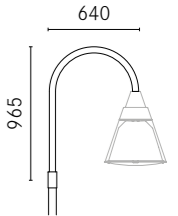
**01AK935C0 - Sablé 100**

B15 Braccio pastorale L 810mm Ø60mm per palo Ø102mm

B15 Crosse courbe L 810mm Ø60mm pour poteau Ø102mm

B15 Brazo báculo L 810mm Ø60mm por columna Ø102mm

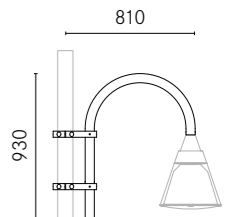
**01AK936C0 - Sablé 100**

B16 Braccio pastorale doppio L 810mm Ø60mm per palo Ø102mm

B16 Crosse double courbe L 810mm Ø60mm pour poteau Ø102mm

B16 Brazo doble báculo L 810mm Ø60mm por columna Ø102mm

